

USER MANUAL

EMEITS, EMEITHS

ALERTWERKS TEMPERATURE SENSOR STRINGS

24/7 TECHNICAL SUPPORT AT 1.877.877.2269 OR VISIT BLACKBOX.COM



BLACK BOX

CHAPTER 1: INTRODUCTION AND INSTALLATION

INTRODUCTION

EMEITS, AlertWerks Temperature Sensor String, and EMEITHS, AlertWerks Temperature/Humidity Sensor String, are Thermal Map Sensors (TMS) designed for use with our AlertWerks Wired Gateways. These sensors can help you locate hot spots in your server cabinets.

The TMS sensor includes six Temperature Sensors and optional two Humidity sensors that are mounted within your server cabinet in the front and rear of the cabinet.

Both the EMEITS and EMEITHS only use one sensor port on the Gateway.

Pre-wired to be easily installed in your cabinet, the sensors are placed at the top, middle, and bottom - front and rear of the cabinet. This sensor configuration monitors the cabinet's air intake, exhaust temperatures, and its temperature differential from the front to the rear. Use Thermal Map sensors to identify cabinet hot spots and problem areas.

This manual will explain how to install and configure the sensor with Web UI options.

Although we focus on the EMEITS sensor, which has six temperature sensors, the configuration process is the same for the EMEITHS.

NOTE: The TMS sensors are only compatible with the AlertWerks Wired Plus Gateways and will not work on older hubs. These sensors will also not work on EMEMS prior to version v13.0.

THERMAL MAP INSTALLATION

TMS sensors are easy to install. They ship pre-wired and ready to mount with magnetic fasteners, cable ties, or ultra high bond adhesive tape to hold them in position in your cabinet.

As shown in Figure 1-1 below, mount each sensor on the front and rear doors of your perforated cabinet so they are exposed directly to the airflow in and out of the rack.



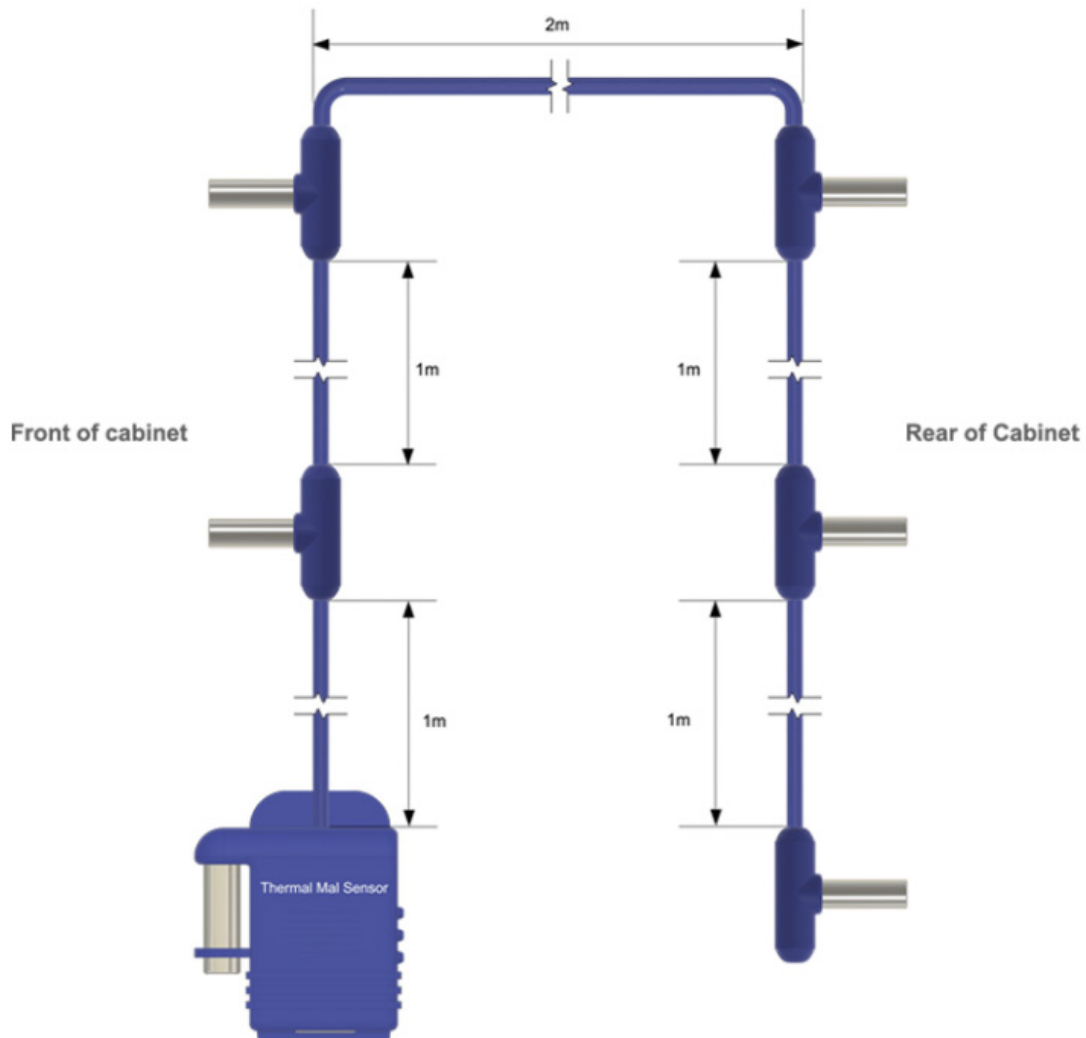

FIGURE 1-1: MOUNTING DIAGRAM

On sealed cabinets, the sensors can still be mounted on the inside and provide the same monitoring of the temperature differential between front and rear while ensuring that airflow is distributed across the cabinet.

Figure 1-2 below shows an illustration example.

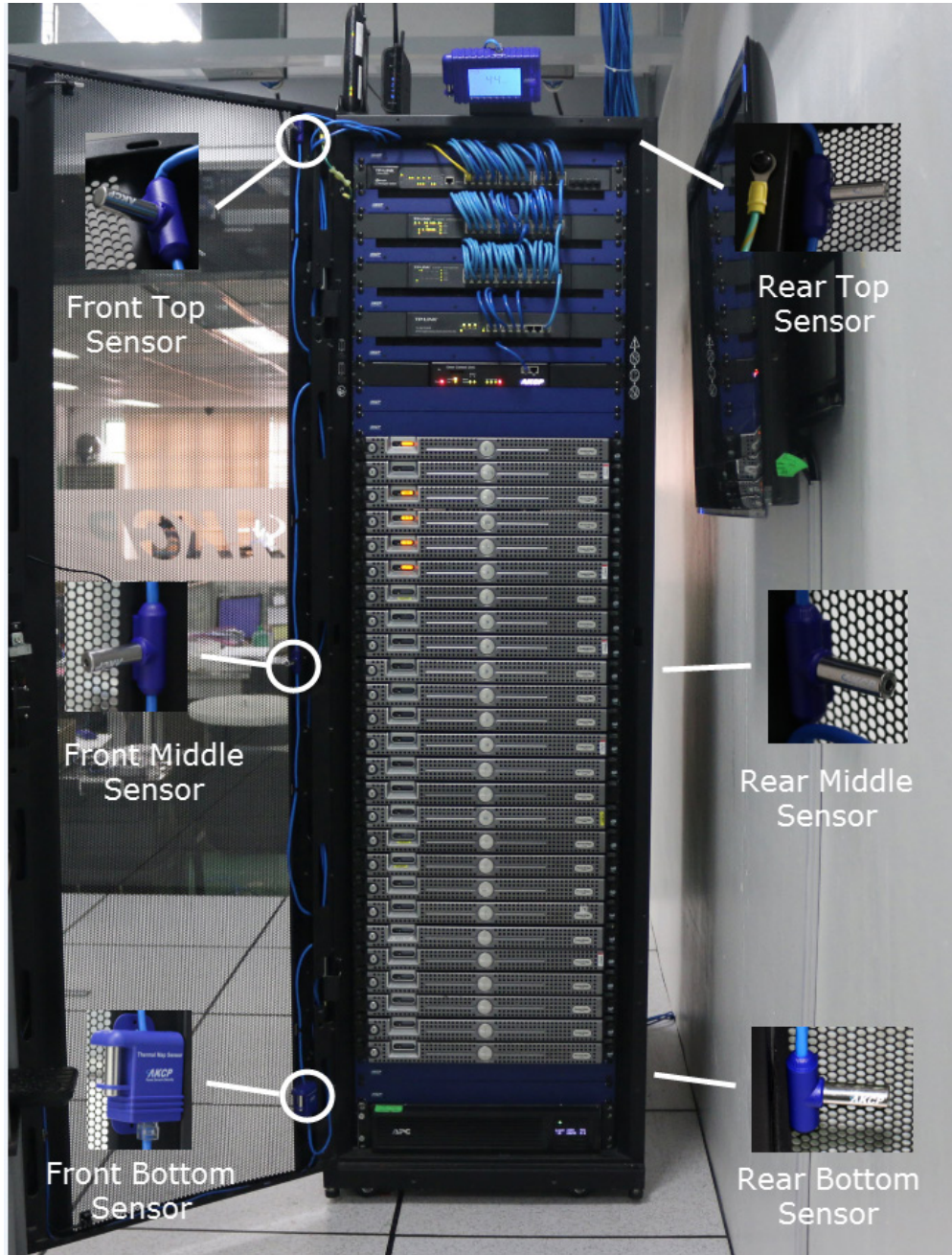

FIGURE 1-2: INSTALLATION EXAMPLE (FRONT AND REAR OF CABINET)

Since the sensor cable is extendable up to a maximum of 59.1 feet (18 meters), you can monitor multiple cabinets from a single IP address. Up to 12 thermal map sensors can be connected to a single AlertWerks Wired Gateway.

TECHNICAL DRAWING

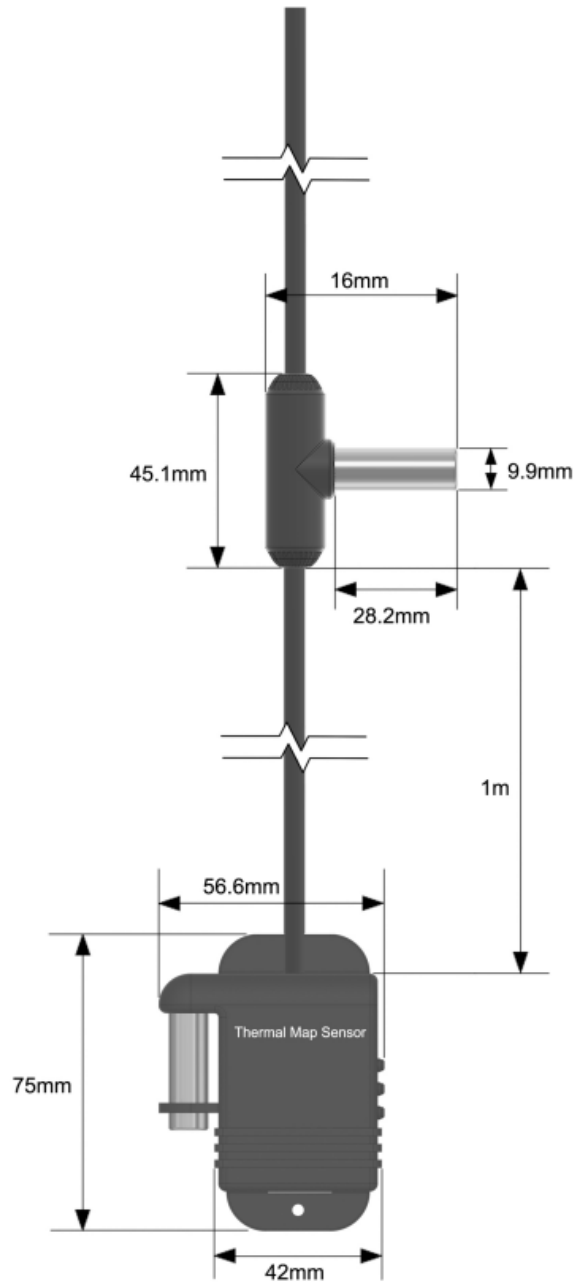

FIGURE 1-3: TECHNICAL DRAWING

CHAPTER 2: WEB UI CONFIGURATION & RACK MAP SETUP

WEB UI CONFIGURATION & RACK MAP SETUP

Figure 2-1 shows the Summary / Monitoring page where you can see the connected Thermal Map as multiple sensors.

For example from the Temperature/Humidity sensor you can easily identify which port it is plugged in to on the unit.

NOTE: Sensors can be renamed for easier identification.

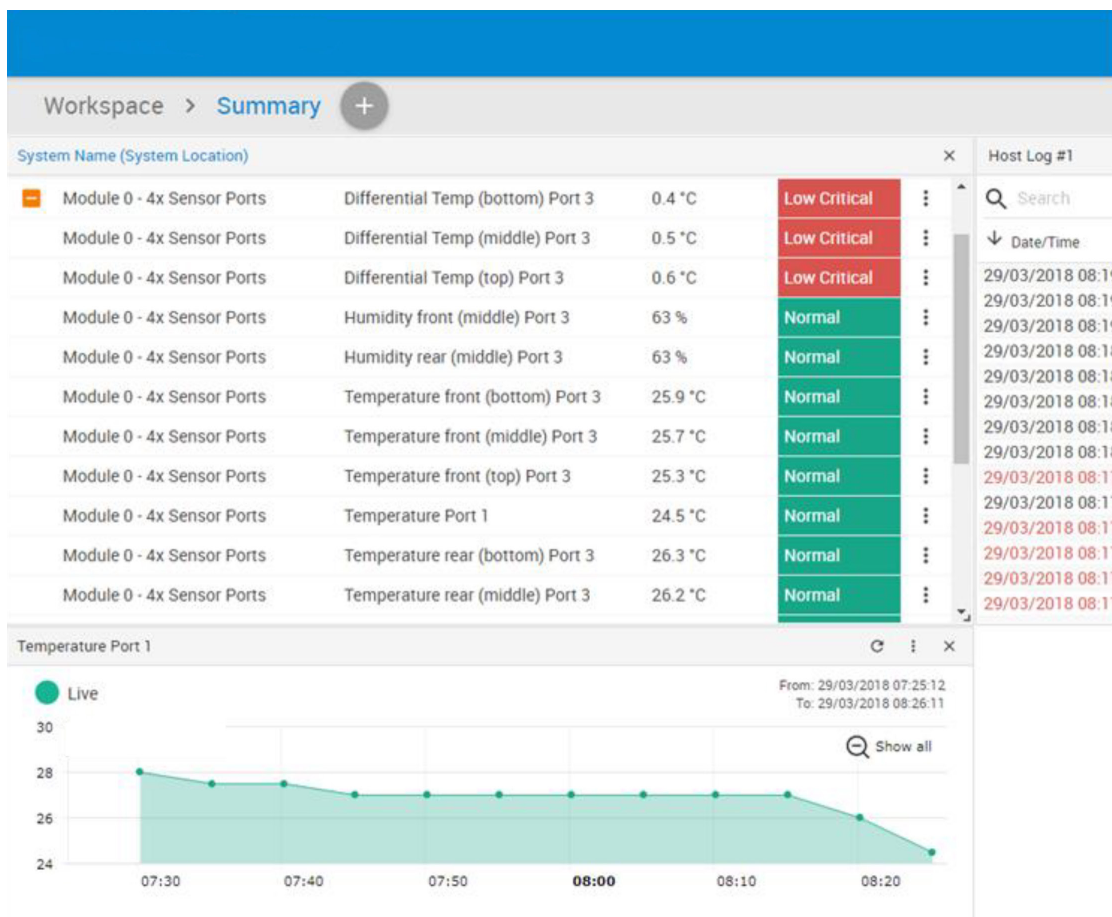

FIGURE 2-1: SUMMARY PAGE

CHAPTER 2: WEB UI CONFIGURATION & RACK MAP SETUP

From the main menu click on the “Sensors” option, as shown in Figure 2-2 below.

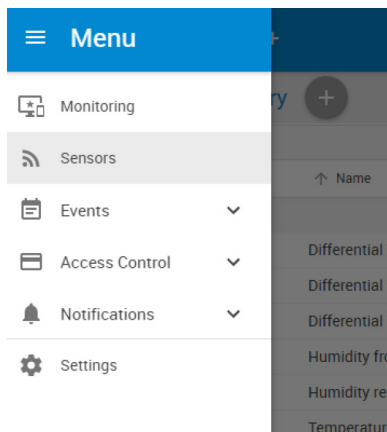

FIGURE 2-2: SCREENSHOT CONTAINING SENSORS OPTION

On the Sensors page, you'll see the Thermal Map as a single sensor, as shown in Figure 2-3 below.

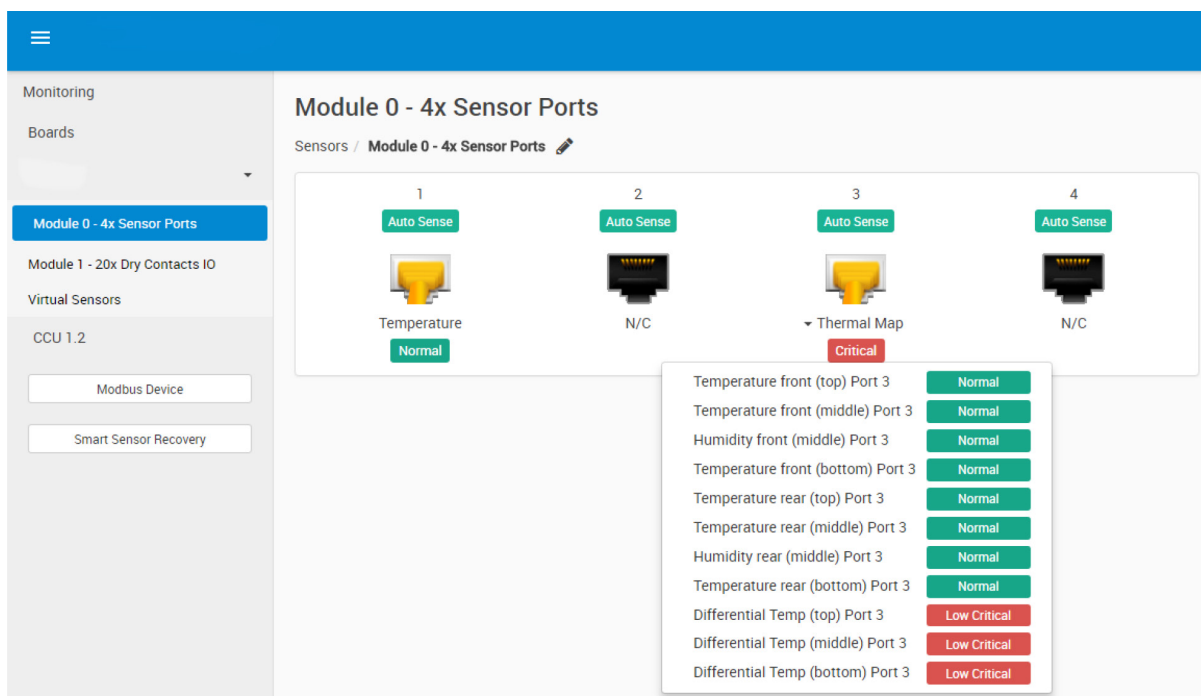

FIGURE 2-3: SCREENSHOT SHOWING THERMAL MAP SENSOR

CHAPTER 2: WEB UI CONFIGURATION & RACK MAP SETUP

The screenshot shows this sensor with the optional two humidity sensors. There are the 6 temperature sensors, 3 for the front of the cabinet and 3 for the rear. The Differential Temp sensors monitor and display the measurements of the front to rear temperature differential.

To manage a sensor in the Thermal Map, click on the image for the list of all sensors. Then click on one that you wish to configure, as shown in Figure 2-4.

NOTE: Do not exceed the maximum supported cable length for the Thermal Map Sensors. The maximum extension cable length from the base units sensor port to the TMS using CAT5 is 59.1 feet (18 meters).

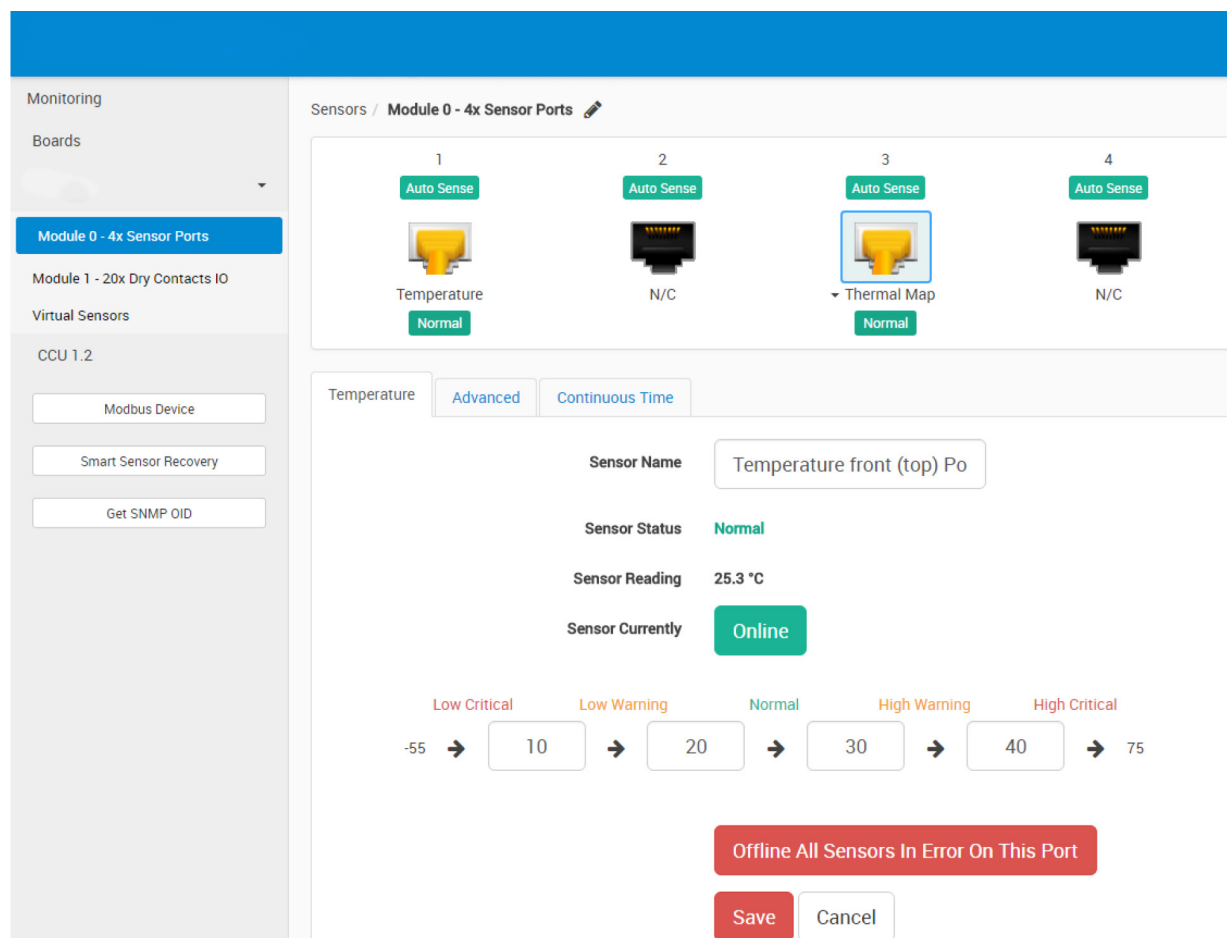

FIGURE 2-4: SENSOR CONFIGURATION SCREEN

Thermal Map sensors and standalone sensors have the same configuration and options.

Refer to the EME168A/EME164A manual for detailed configuration of the Temperature/Humidity sensors.

NOTE: The Temperature Search option is not available for the Thermal Map sensor; it is used by the Daisy-Chain Temperature Sensor (DCT).

CHAPTER 2: WEB UI CONFIGURATION & RACK MAP SETUP

Rack Map View and Temperature Differential

The AlertWerks Wired Gateway and EMEMS software display the thermal sensor's integrated "RackMap" view. This shows the status and value of each sensor and its position on the cabinet, as well as animated arrows denoting the front to rear temperature differential and its status.

NOTE: The TMS sensors are only compatible with the AlertWerks Wired Gateways and will not work on older hubs. These sensors will also not work on EMEMS prior to version v13.0.

RACK MAP SETUP

As shown in Figure 2-5 below, navigate back to the Monitoring page in the AlertWerks Wired's web UI.

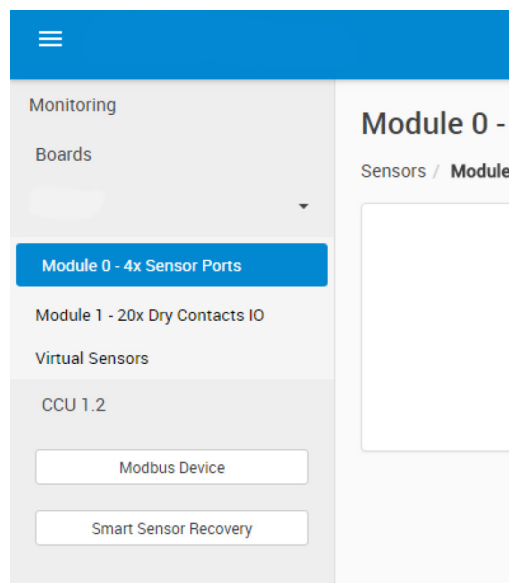

FIGURE 2-5: MENU WITH MONITORING OPTION

Then click on the "Workspace" option shown in Figure 2-6 below.

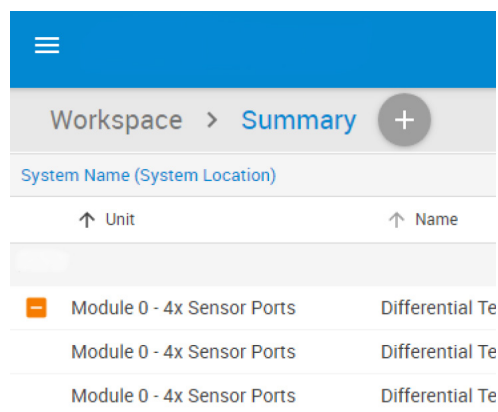

FIGURE 2-6: SCREENSHOT SHOWING WORKSPACE OPTION

CHAPTER 2: WEB UI CONFIGURATION & RACK MAP SETUP

After you click on the “MAPS” option as shown in Figure 2-7 below, use the “Add Rack Map” button to add your new Rack Map..

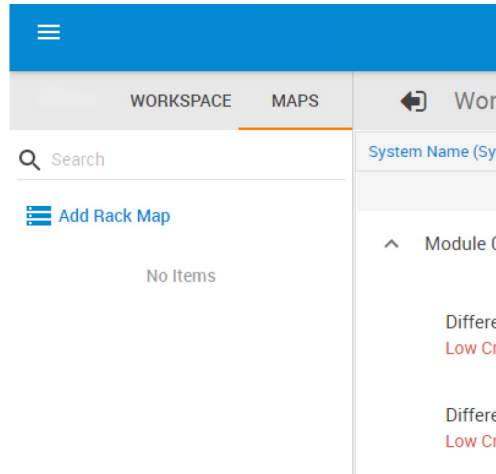

FIGURE 2-7: OPTIONS, INCLUDING WORKSPACE AND MAPS

You can then label or name your new Rack Map as shown in Figure 2-8 below.

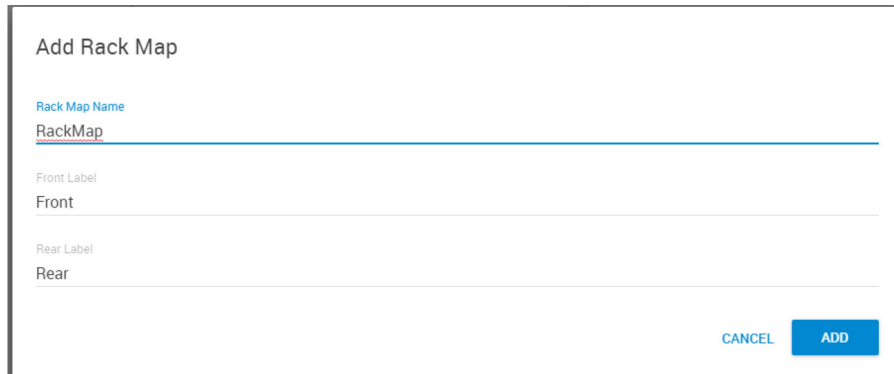

FIGURE 2-8: “ADD RACK MAP” OPTION

CHAPTER 2: WEB UI CONFIGURATION & RACK MAP SETUP

After naming your new Rack Map and clicking on the “Add” button, you will see the new Rack Map in the MAPS column as shown in Figure 2-9 below. In this example we have named the new Rack Map “Steve’s RackMap.”

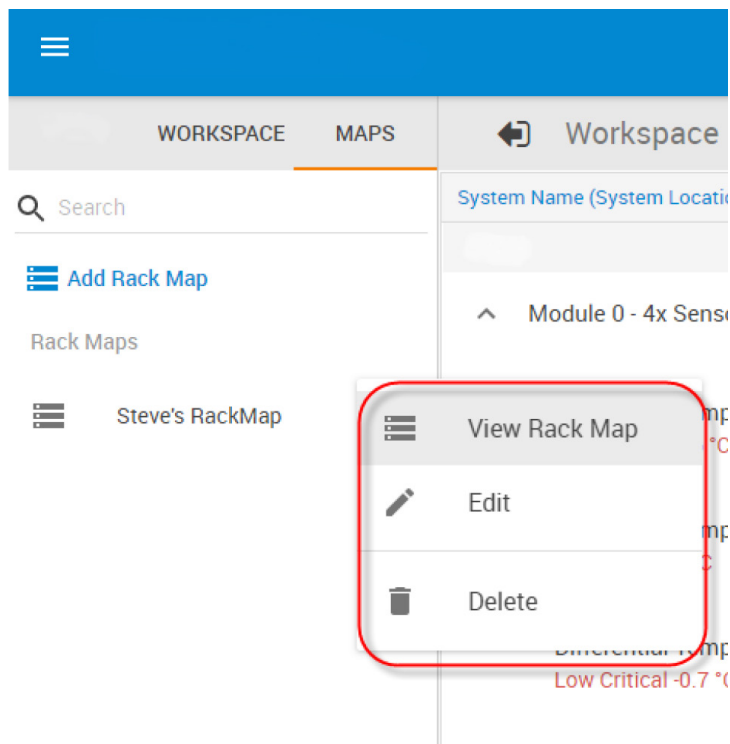

FIGURE 2-9: SCREENSHOT SHOWING NAMED MAP

If you want to edit or delete the new Rack Map, click on the menu button to the right of the Rack Map. You can also add the new Rack Map to your Workspace by choosing the “View Rack Map.”

CHAPTER 2: WEB UI CONFIGURATION & RACK MAP SETUP

You can drag and drop your new Rack Map to your Workspace as shown in Figure 2-10 below.

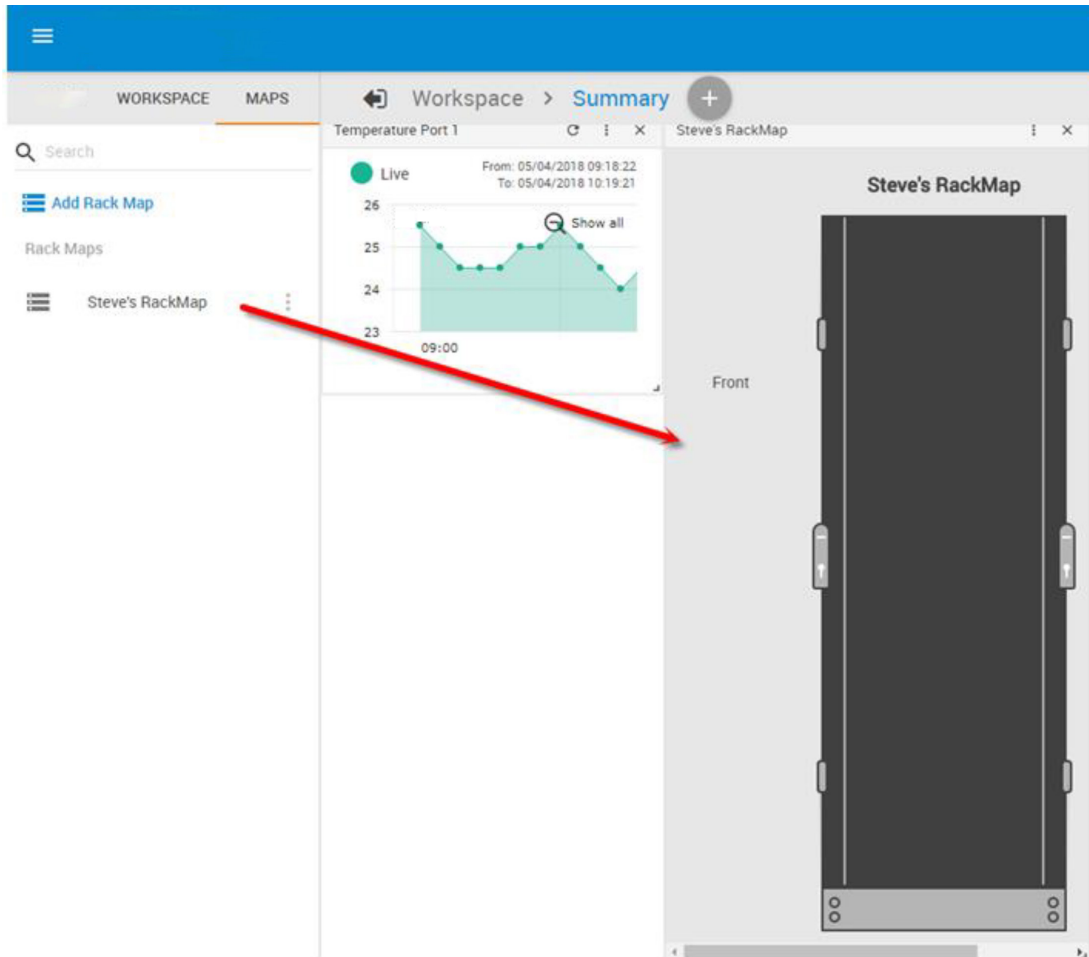

FIGURE 2-10: DRAG AND DROP

CHAPTER 2: WEB UI CONFIGURATION & RACK MAP SETUP

To add the Thermal Map sensors to your new Rack Map, click on the Workspace column which will display the Thermal Map that is connected to the AlertWerks Wired Gateway, and then simply drag and drop one of the Thermal Map sensors onto the new Rack Map. In a few seconds the temperatures and graphics will be displayed as shown in Figure 2-11 below.

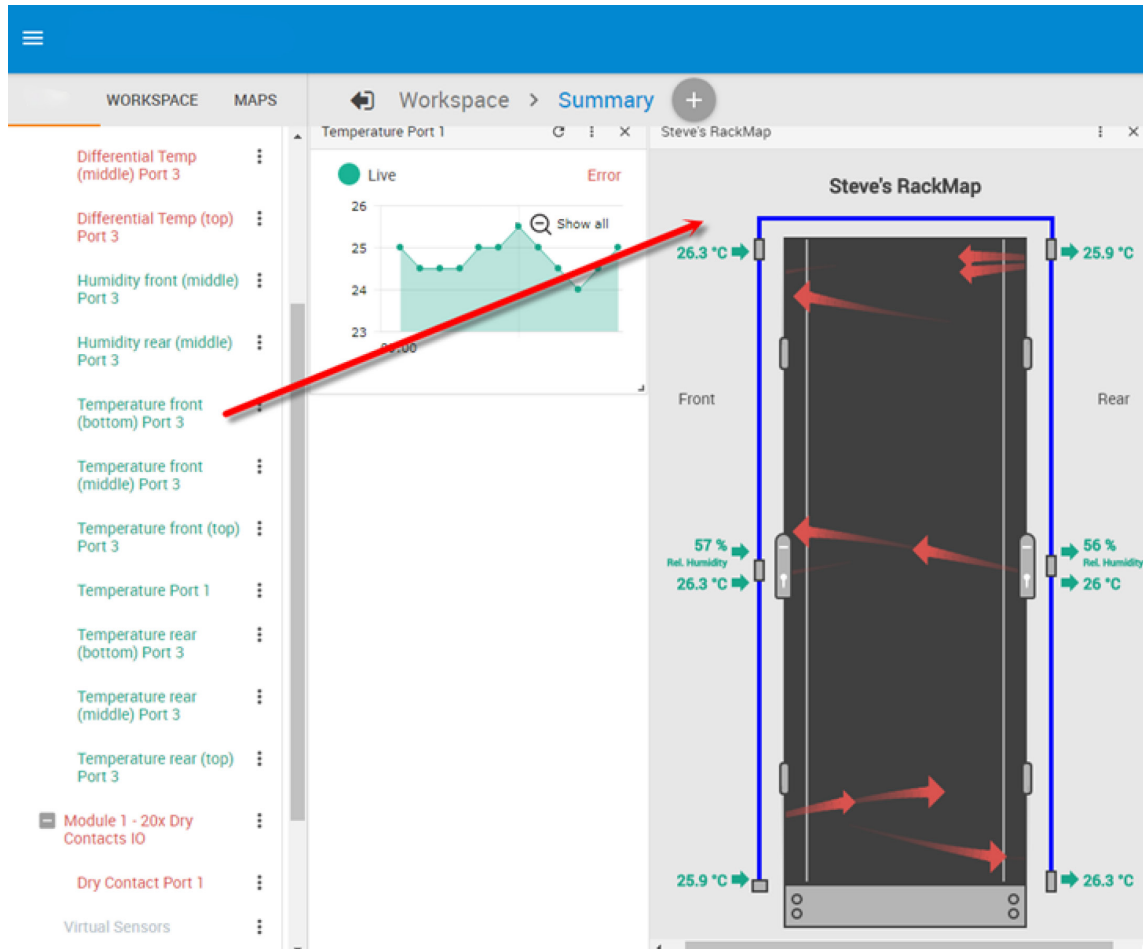

FIGURE 2-11: ADDING THERMAL MAP SENSORS TO NEW RACK MAP

CHAPTER 2: WEB UI CONFIGURATION & RACK MAP SETUP

To navigate back to the main Summary page you can click on the back arrow button shown in the Figure 2-12 below.

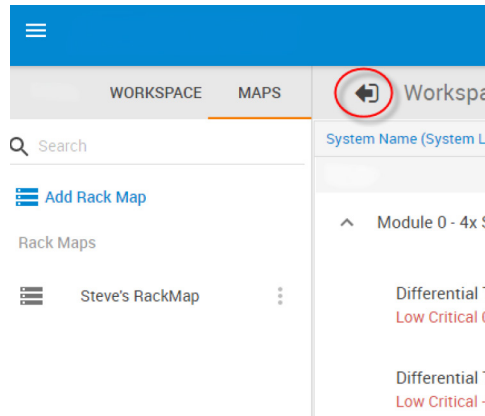

FIGURE 2-12: SCREENSHOT CONTAINING BACK ARROW BUTTON

APPENDIX A: REGULATORY INFORMATION

A.1 FCC STATEMENT

This equipment has been tested and found to comply with the regulations for a Class B digital device, pursuant to Part 15 of the FCC Rules. These limits are designed to provide reasonable protection against harmful interference when the equipment is operated in a commercial environment. This equipment generates, uses, and can radiate radio frequency energy and, if not installed and used in accordance with this Quick Installation Guide, may cause harmful interference to radio communications. Operation of this equipment in a residential area is likely to cause harmful interference in which case, the user will be required to correct the interference at his/her own expense.

A.2 CE STATEMENT

This is a Class B product in a domestic environment, this product may cause radio interference, in which case the user may be required to take adequate measures.

A.3 ROHS

This product is RoHS compliant.

APPENDIX A: REGULATORY INFORMATION

A.4 NOM STATEMENT

1. Todas las instrucciones de seguridad y operación deberán ser leídas antes de que el aparato eléctrico sea operado.
2. Las instrucciones de seguridad y operación deberán ser guardadas para referencia futura.
3. Todas las advertencias en el aparato eléctrico y en sus instrucciones de operación deben ser respetadas.
4. Todas las instrucciones de operación y uso deben ser seguidas.
5. El aparato eléctrico no deberá ser usado cerca del agua—por ejemplo, cerca de la tina de baño, lavabo, sótano mojado o cerca de una alberca, etc.
6. El aparato eléctrico debe ser usado únicamente con carritos o pedestales que sean recomendados por el fabricante.
7. El aparato eléctrico debe ser montado a la pared o al techo sólo como sea recomendado por el fabricante.
8. Servicio—El usuario no debe intentar dar servicio al equipo eléctrico más allá a lo descrito en las instrucciones de operación. Todo otro servicio deberá ser referido a personal de servicio calificado.
9. El aparato eléctrico debe ser situado de tal manera que su posición no interfiera su uso. La colocación del aparato eléctrico sobre una cama, sofá, alfombra o superficie similar puede bloquea la ventilación, no se debe colocar en libreros o gabinetes que impidan el flujo de aire por los orificios de ventilación.
10. El equipo eléctrico deber ser situado fuera del alcance de fuentes de calor como radiadores, registros de calor, estufas u otros aparatos (incluyendo amplificadores) que producen calor.
11. El aparato eléctrico deberá ser conectado a una fuente de poder sólo del tipo descrito en el instructivo de operación, o como se indique en el aparato.
12. Precaución debe ser tomada de tal manera que la tierra física y la polarización del equipo no sea eliminada.
13. Los cables de la fuente de poder deben ser guiados de tal manera que no sean pisados ni pellizcados por objetos colocados sobre o contra ellos, poniendo particular atención a los contactos y receptáculos donde salen del aparato.
14. El equipo eléctrico debe ser limpiado únicamente de acuerdo a las recomendaciones del fabricante.
15. En caso de existir, una antena externa deberá ser localizada lejos de las líneas de energía.
16. El cable de corriente deberá ser desconectado del cuando el equipo no sea usado por un largo periodo de tiempo.
17. Cuidado debe ser tomado de tal manera que objetos líquidos no sean derramados sobre la cubierta u orificios de ventilación.
18. Servicio por personal calificado deberá ser provisto cuando:
 - A: El cable de poder o el contacto ha sido dañado; u
 - B: Objetos han caído o líquido ha sido derramado dentro del aparato; o
 - C: El aparato ha sido expuesto a la lluvia; o
 - D: El aparato parece no operar normalmente o muestra un cambio en su desempeño; o
 - E: El aparato ha sido tirado o su cubierta ha sido dañada.



APPENDIX B: DISCLAIMER/TRADEMARKS

B.1 DISCLAIMER

Black Box Corporation shall not be liable for damages of any kind, including, but not limited to, punitive, consequential or cost of cover damages, resulting from any errors in the product information or specifications set forth in this document and Black Box Corporation may revise this document at any time without notice.

B.2 TRADEMARKS USED IN THIS MANUAL

Black Box and the Black Box logo type and mark are registered trademarks of BB Technologies, Inc.

Any other trademarks mentioned in this manual are acknowledged to be the property of the trademark owners.

**NEED HELP?
LEAVE THE TECH TO US**

**LIVE 24/7
TECHNICAL
SUPPORT**

1.877.877.2269

BLACK BOX[®]

© COPYRIGHT 2022, BLACK BOX CORPORATION. ALL RIGHTS RESERVED.
EMEITS_EMEITHS_USER_REV1.PDF